

Makita

PARTI DI RICAMBIO

Modello M440 230V~

Cod. 99611B8B

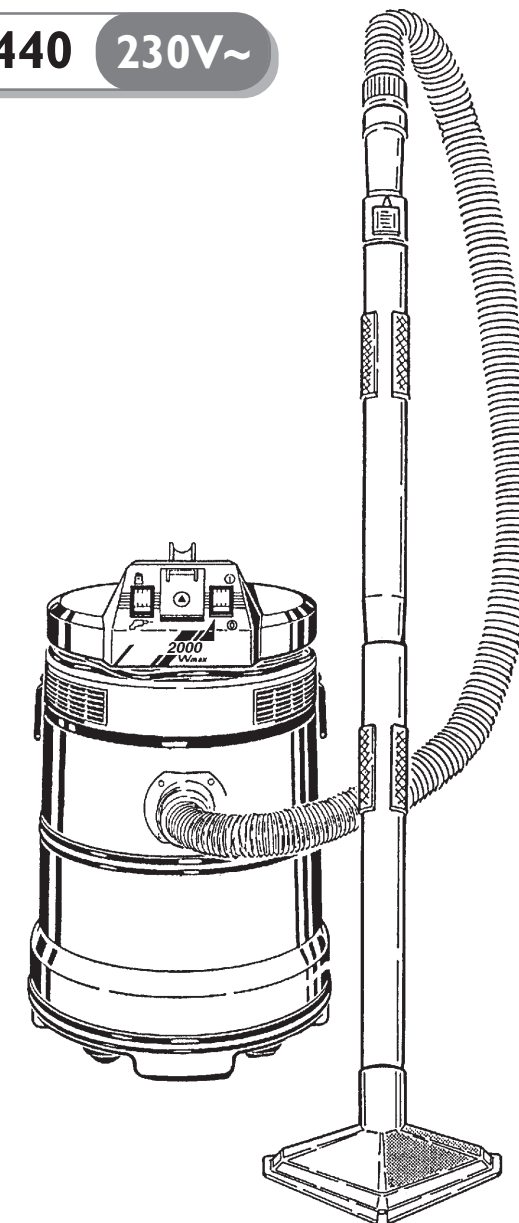

Makita

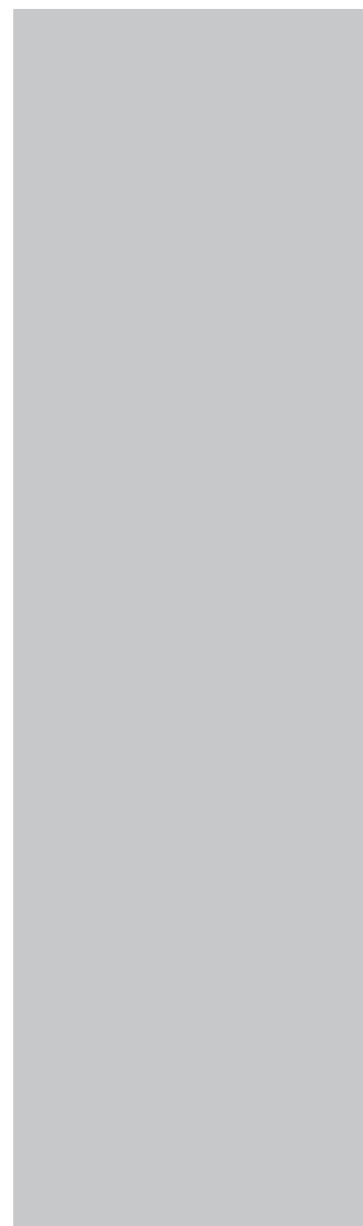
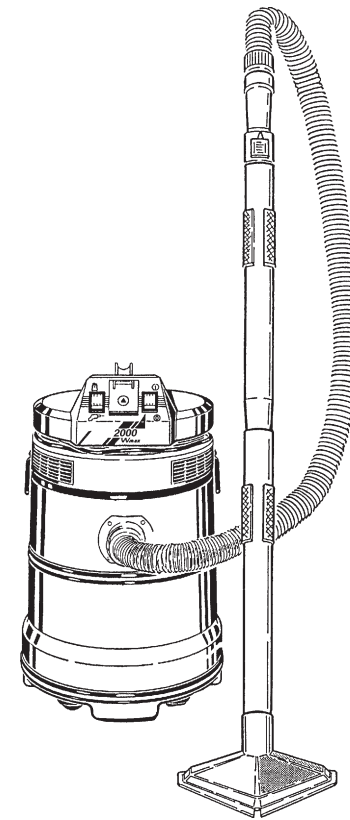
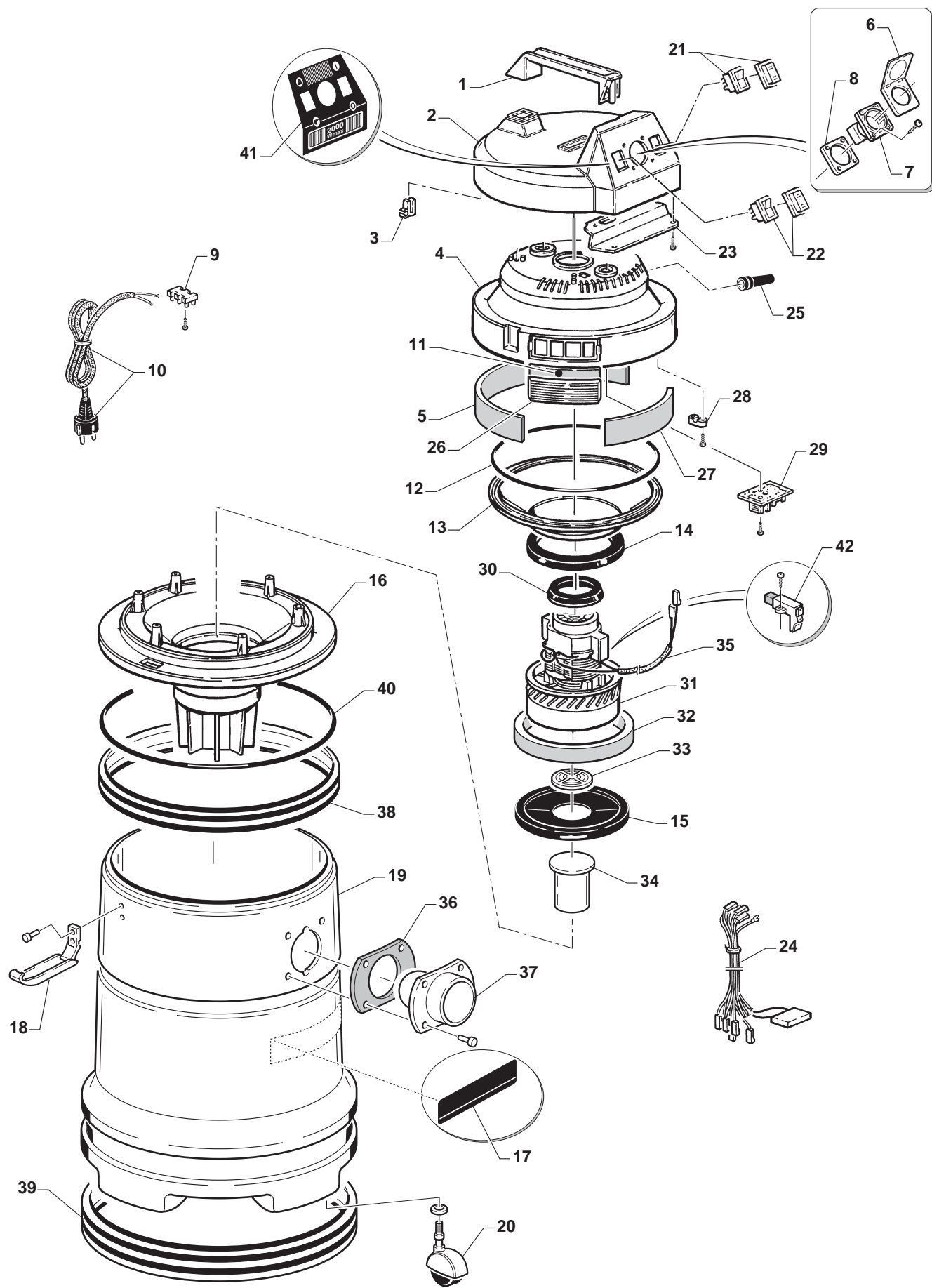

Blank lined area for notes or additional information.

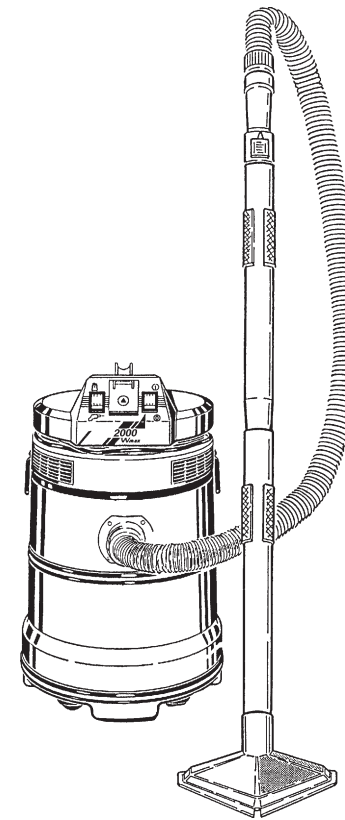
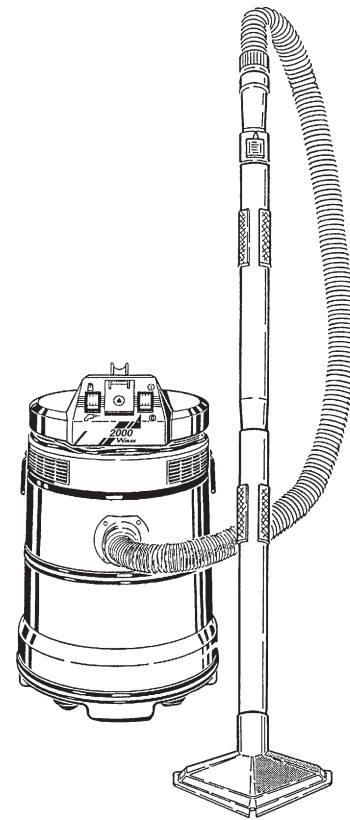

Pos.	Descrizione	Codice	Prezzo € (Cad)
01	Impugnatura	50310B8B	
02	Calotta	50305B8B	
03	Forcella fermacavo	50335BEN	
04	Coprimotore	50181B0A	
05	Silenziatore lungo alla calotta	83022B8X	
06	Cornice + coperchio	80202B8N	
07	Presca Schuko	80200B8N	
08	Ghiera per presa	50315BDV	
09	Morsetto tripolare	80029B0I	
10	Cavo di alimentazione	80017B0N	
11	Filtro alla griglia	83021B8X	
12	Guarnizione tonda	70016B8N	
13	Diaframma	50104B8V	
14	Guarnizione tenuta diaframma	70057B0N	
15	Guarnizione inferiore tenuta motore	70032B0N	
16	Supporto motore	50179B8B	
17	Adesivo contenitore	85637B8V	
18	Cerniera completa	01015B0A	
19	Contenitore	60027BJA	
20	Ruota pivotante	30086B0X	
21	Interruttore bipolare nero con led rosso	80041BDN	
22	Interruttore unipolare	80042BDN	
23	Piastra di chiusura	50300BDV	
24	Serie cavetti	80101B8V	
25	Guidacavo	50338BEN	
26	Griglia uscita aria	50170B8A	
27	Silenziatore corto alla calotta	83023B8X	
28	Fermacavo	50333BEN	
29	Scheda elettronica integrata	80209BDX	
30	Ammortizzatore superiore motore	70060B8N	
31	Motore ED98/1000W/BS/240V~	20052B0X	
32	Anello silenziatore	83020B8X	
33	Griglia di protezione	50183B0V	
34	Galleggiante	50077B0V	
35	Tubetto PVC nero mm. 110 - ø 6 mm.	60235BHN	
36	Guarnizione in polietilene espanso	70082B5X	
37	Raccordo entrata aria	50079B0A	
38	Fascia paraurti superiore per contenitore cm. 96	60036BLU	
39	Fascia paraurti inferiore per contenitore cm. 112	60037BLU	
40	Semitondo gommaspugna	70011B0N	
41	Adesivo calotta	85642B8V	
42	Inserto porta spazzola	80051B0X	

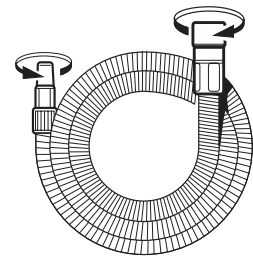

A1

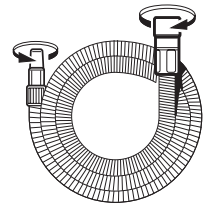

A2

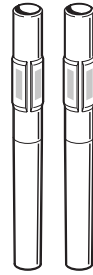

A3



A4

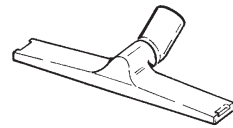

A5

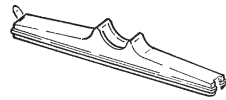

A6

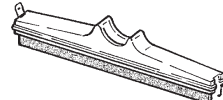

A7



A8



A9

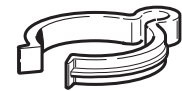

A10

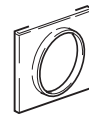

A11

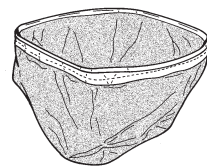
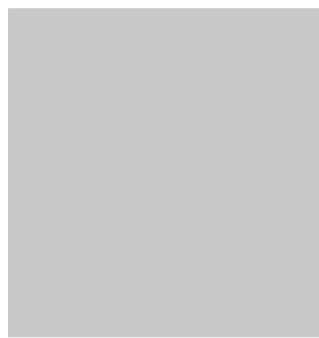

A12



A13

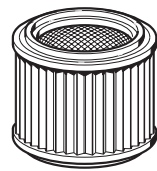

A14



A15

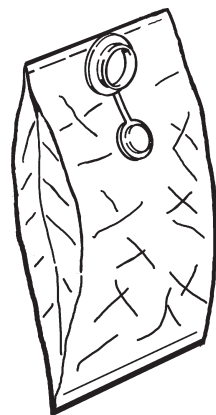

A16

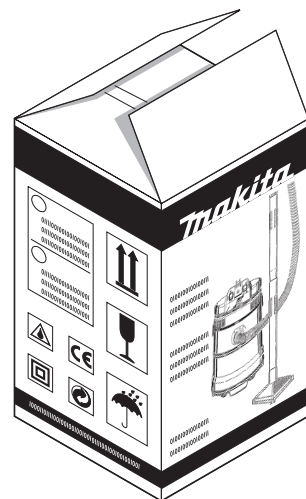

A17

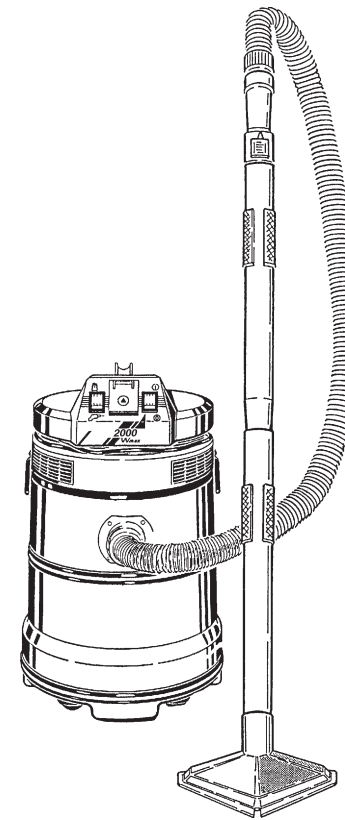

Pos.	Descrizione	Codice	Prezzo € (Cad)
A01	Tubo flessibile ø 45 - L=mt. 2 completo di manicotti	01316B0N	
A02	Tubo flessibile per elettroutensile ø 25 - L= mt. 3 completo di manicotti	01321B0N	
A03	Prolunga rigida ø 45	50091B0N	
A04	Impugnatura ergonomica ø 45	50093B0N	
A05	Spazzola multiuso ø 45	60277B0N	
A06	Inserto polvere	60279B0N	
A07	Racla per raccogli liquidi	60278B0N	
A08	Bocchetta a lancia ø 45	50080B0N	
A09	Bocchetta triangolare ø 45	50089B0N	
A10	Ghiera blocca cavo per A.S.S.	50318BHN	
A11	Anello sacco raccogli polvere	50707B0N	
A12	Sacco filtro P.P.	83100BJA	
A13	Filtro-mousse	83035BHB	
A14	Elemento filtrante BIA piccolo confezionato	83200BJA	
A15	Elemento filtrante BIA piccolo confezionato + disco adattatore	83201BJA	
A16	Confezione sacco carta verticale (5 pz.)	83134B0K	
A17	Imballo in cartone M440	87327B8I	

Schema elettrico

Legenda colore cavi / Cable colour coding

W	Bianco / White
Bk	Nero / Black
R	Rosso / Red
Br	Marrone / Brown
Bl	Blu / Blue
Gr	Verde / Green
Y	Giallo / Yellow

* - con faston - with faston

